

Article number: 604145036115

Description: Timing belt pulley with hub  
HTD 36 14M 115

## Measures

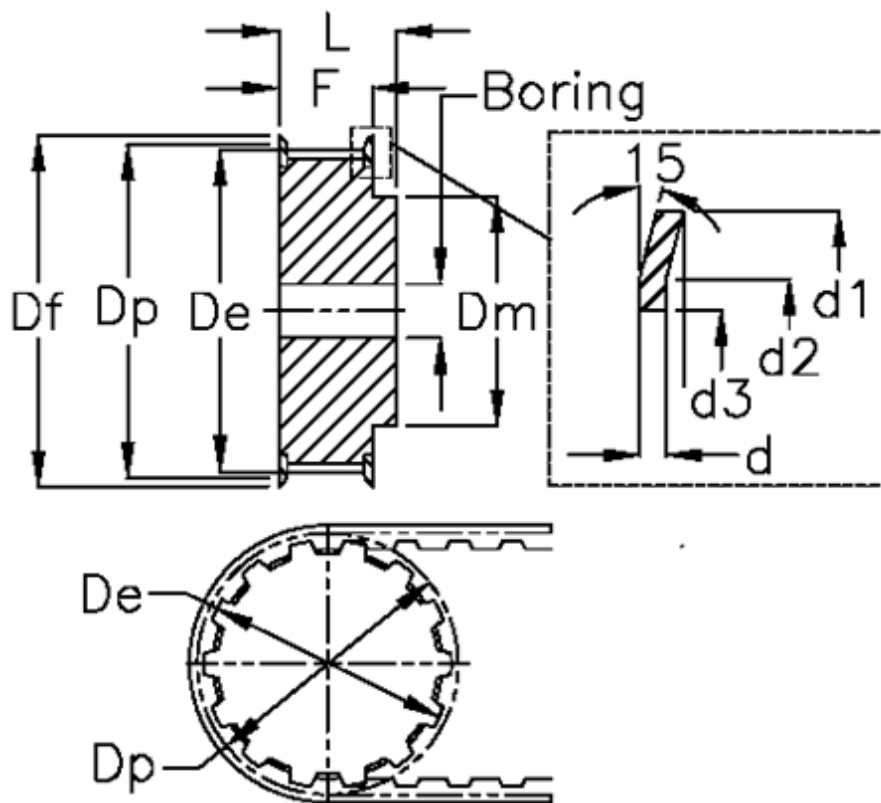

Bore = 32	Dp	= 160.43
d = 2.5	F	= 133
d1 = 168	Flange type	= F52
d2 = 161	L	= 148
d3 = 148	Tooth number	= 36
De = 157.68	Type	= 14M
Df = 168	Weight	= 16.6
Dm = 100	Width	= 115